

WHEN DISASSEMBLING ALUMINUM EXTRUSION, TIGHTEN ALL SETSCREWS AND LOCKS TO PREVENT LOSS DURING SHIPPING

visionary™ IDESIGNS

Using Your Setup Instructions

The Visionary Designs Setup Instructions are created specifically for your configuration. They are laid out sequentially, including an exploded view of the entire display, and then a logical series of detailed steps to assemble the main structure and components. We encourage you to study the instructions **before** attempting to assemble your exhibit.

Each page reminds you to tighten the setscrews after disassembling your exhibit to prevent loss of the locks and setscrews (see below in RED). This is **VERY IMPORTANT**.

Cleaning and Packing Your Display

- 1) Use care when cleaning aluminum extrusion or acrylic inserts. Use only non-abrasive cleaners.
- 2) When cleaning laminate inserts or countertops, use mild cleansers and a soft material such as cotton.
- 3) Keep all display components away from extreme heat and long exposure to sunlight to avoid warping and fading.
- 4) Retain all packing material. It will make re-packing much easier and will reduce the likelihood of shipping damage.



The Tool

Most Visionary Designs exhibits can be assembled with the supplied Hex Key Tool. Occasionally, a flat head screwdriver may be required.



Detail A

Typical Connection



Typical Connection (cont'd)

Most horizontal extrusion connections have a patented expandable lock. This lock inserts into the groove of an opposing extrusion. Tightening the lock with the Hex Key Tool expands the lock and creates a strong positive connection.

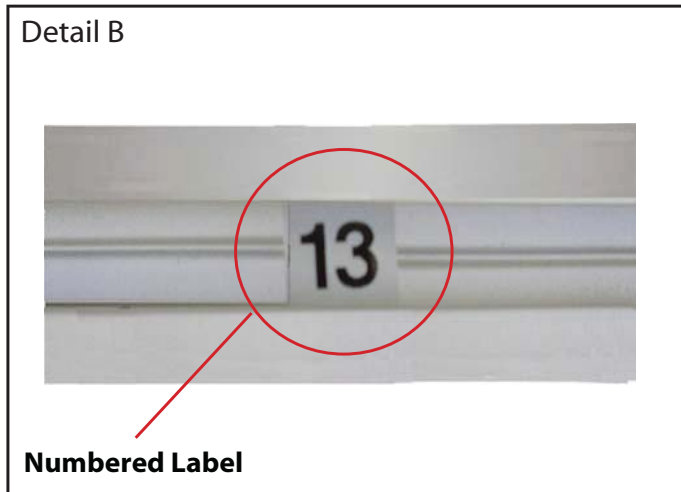

Detail B

Numbered Label

Each extrusion contains a numbered label which corresponds with setup instructions. The label is located within a groove of the extrusion (when possible). With Visionary Designs the labels contain Black numbers unless otherwise specified.



Detail C

Horizontal Inline Connection (remove only one setscrew)

Remove only (1) setscrew when disassembling. Replace setscrew in extrusion after assembling it. Before packing, replace setscrew in extrusion to avoid losing it.

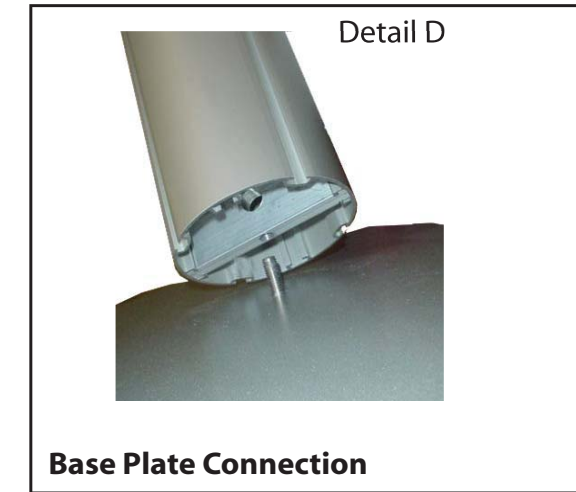

Detail D

Base Plate Connection

Attach base plate to round or square vertical extrusion using the bolt provided. Be careful not to strip the threads.

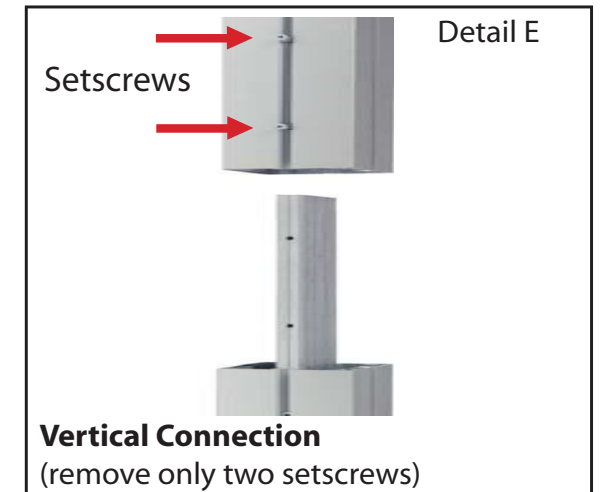

Detail E

Vertical Connection
(remove only two setscrews)

When vertical extrusions are packed in portable cases rather than crates or tubs, they must be broken down into smaller sections which then require assembly.

Remove only (2) setscrews when disassembling. Replace setscrews in extrusion after assembling it. Before packing, replace setscrews in extrusion to avoid losing them.

WHEN DISASSEMBLING ALUMINUM EXTRUSION, TIGHTEN ALL SETSCREWS AND LOCKS TO PREVENT LOSS DURING SHIPPING

866.652.2100

Item	Qty.	Description
1	2	Base Plate
2	1	42" h Lower Square Vertical Extrusion
3	1	42" h Upper Square Vertical Extrusion
2a	1	42" h Lower Square Vertical Extrusion w/ A10 Clamps Attached
3a	1	42" h Upper Square Vertical Extrusion w/ A10 Clamps Attached
4a/4b	1/1	45" w Horizontal Extrusion
5a/5b	1/1	45" w Horizontal Extrusion
6/6a	1/1	2.5" h Angle-Cut Vertical

- Steps:
- 1) Attach vertical extrusions [2] to base plates [1].
 - 2) Attach upper vertical extrusions [3 and 3a] to lower extrusions [2 and 2a] using connection bar [a].
 - 3) Connect horizontal extrusions [4a to 4b and 5a to 5b] together using connection bars [b].
 - 4) Attach horizontal assemblies [4a/4b and 5a/5b] between vertical assemblies as shown.
 - 5) Attach angle-cut verticals to top of assembled backwall where indicated.
 - 6) Apply graphic to back of assembled backwall.
 - 7) Attach light to top of assembled backwall.

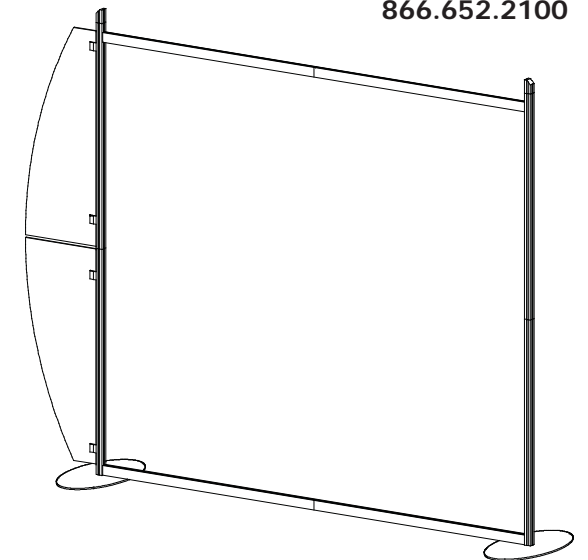

STAR indicates location of knobs on BACKSIDE of unit.

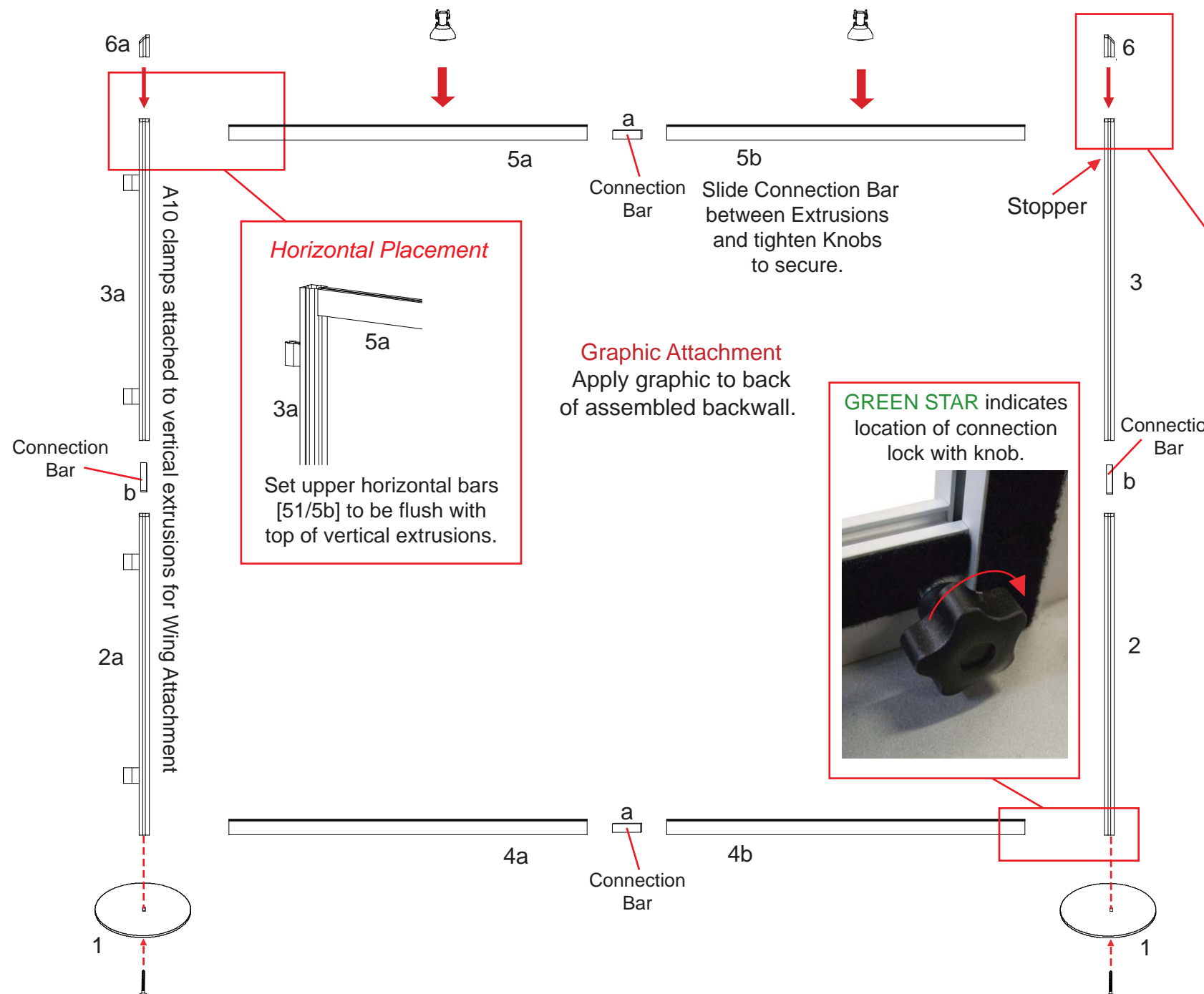
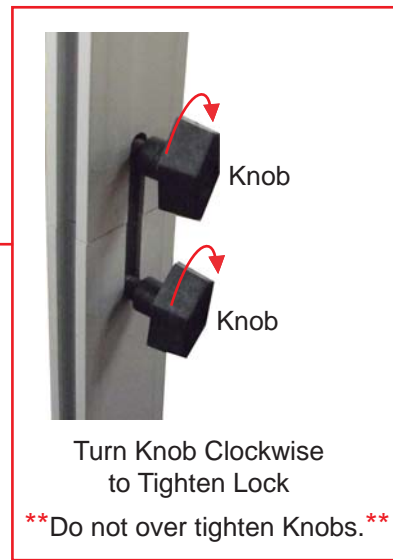

WHEN DISASSEMBLING ALUMINUM EXTRUSION, TIGHTEN ALL SETSCREWS AND LOCKS TO PREVENT LOSS DURING SHIPPING

866.652.2100

Item	Qty.	Description
7	1	9.2856" h Vertical extrusion
8	1	9.2856" h Vertical extrusion
9	1	43.66" w Curved Horizontal Extrusion

- Steps:
- 1) Connect curved horizontal extrusion [9] between vertical extrusions [7 and 8].
 - 2) Attach assembled header to top of assembled backwall as shown.

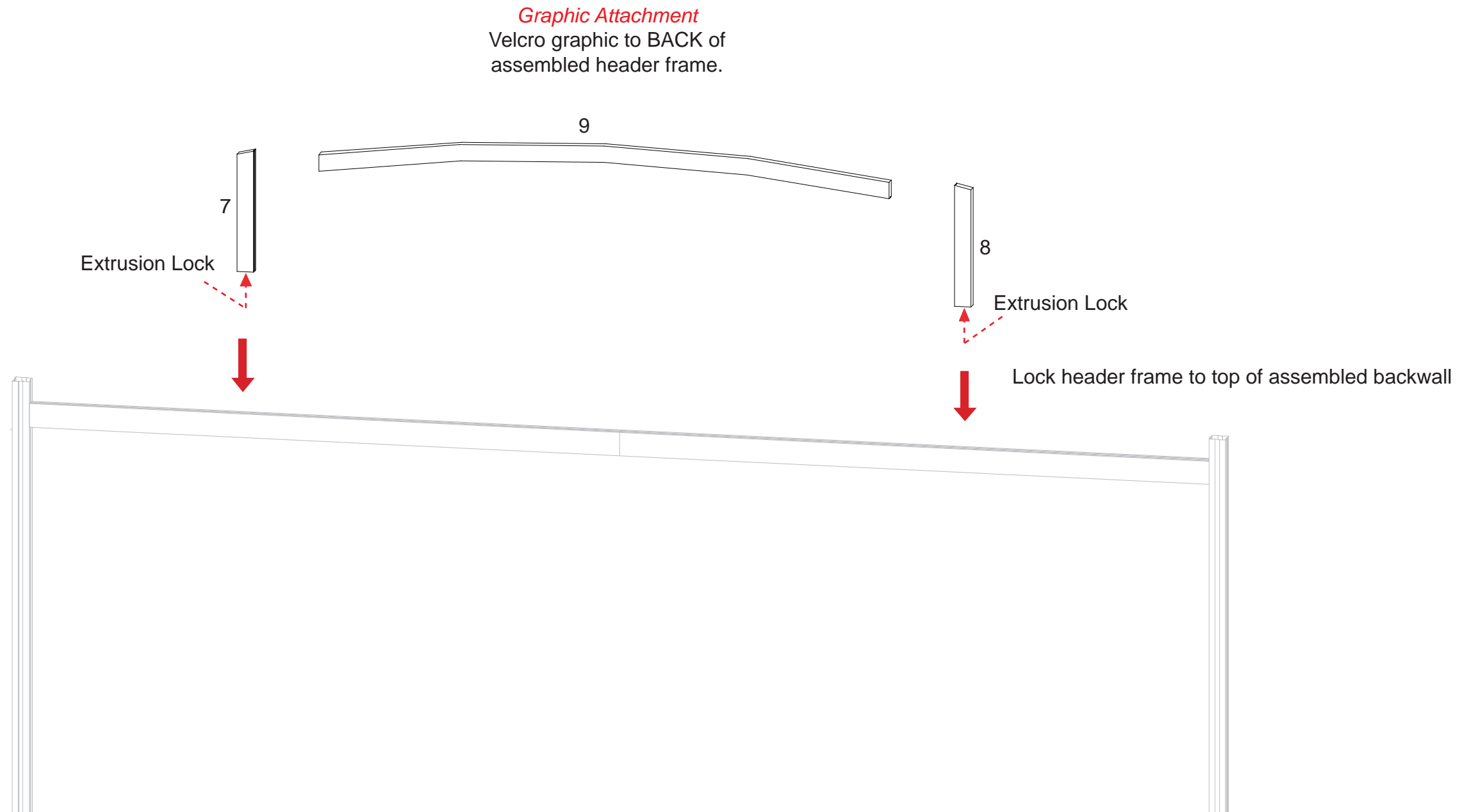

WHEN DISASSEMBLING ALUMINUM EXTRUSION, TIGHTEN ALL SETSCREWS AND LOCKS TO PREVENT LOSS DURING SHIPPING

Wing Attachment

Slide A10 Clamp into groove of square extrusion.

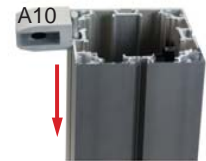

When desired location is found, tighten set screw to secure.

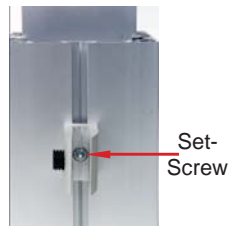

Tighten black plastic set screw to secure Wing in place.

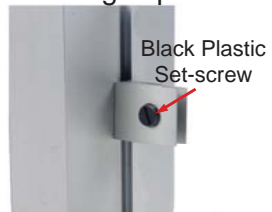

**Note: A10 clamps must stay attached with verticals*

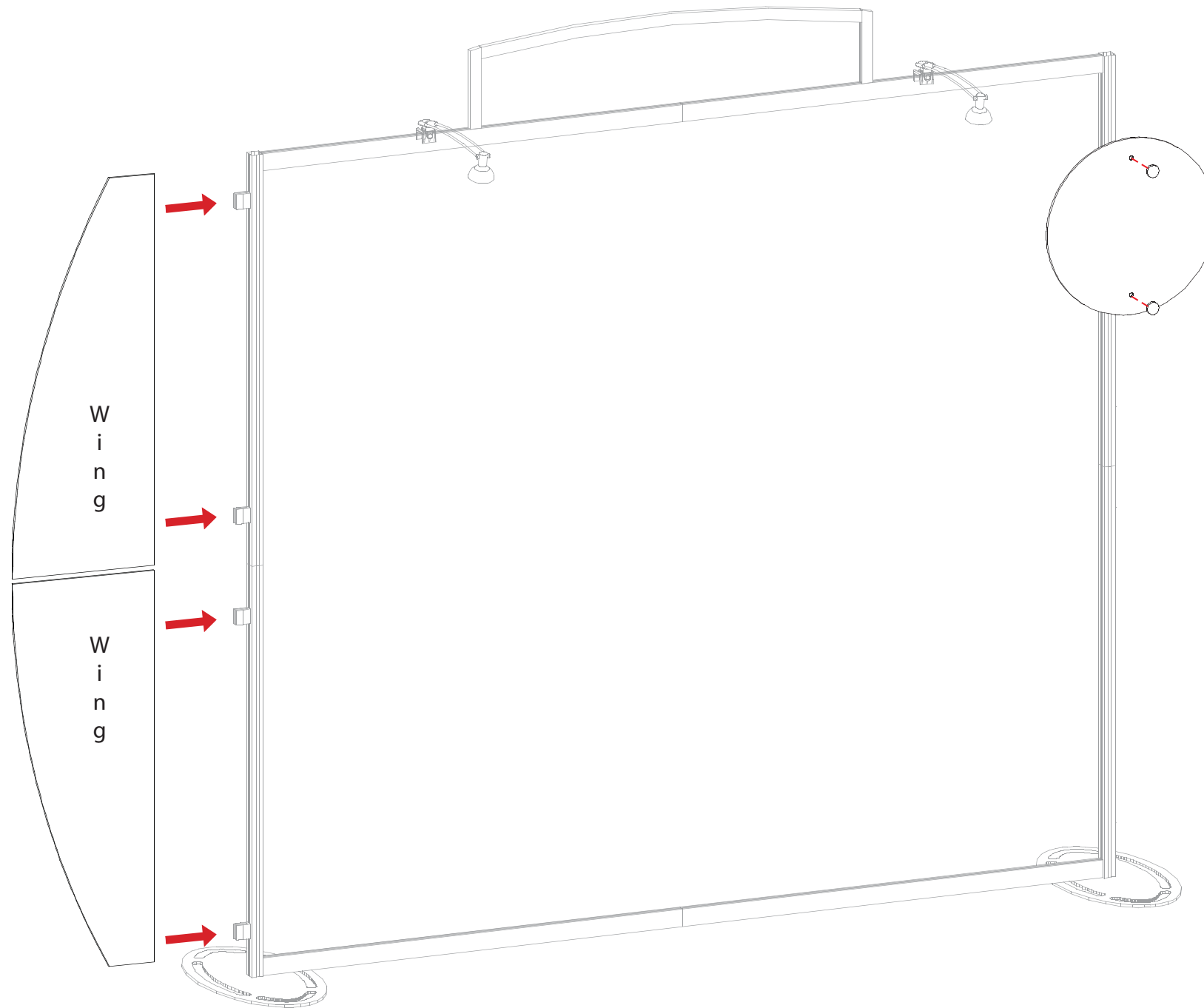

Graphic Attachment

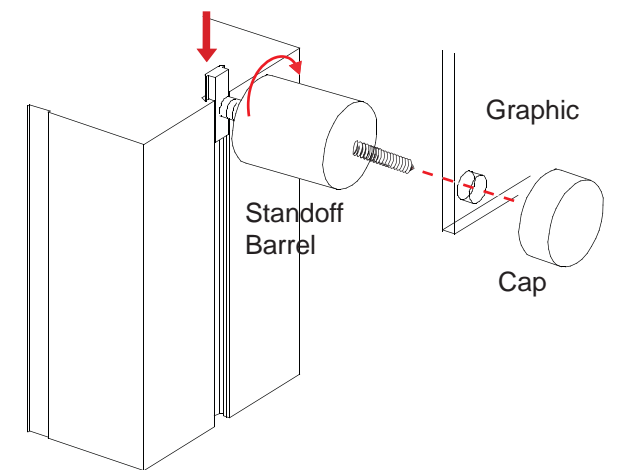

Slide connector on back of standoff barrels into groove of extrusion and twist to secure in place. Secure graphic to standoffs using screw caps.

WHEN DISASSEMBLING ALUMINUM EXTRUSION, TIGHTEN ALL SETSCREWS AND LOCKS TO PREVENT LOSS DURING SHIPPING

(1) Backwall Components

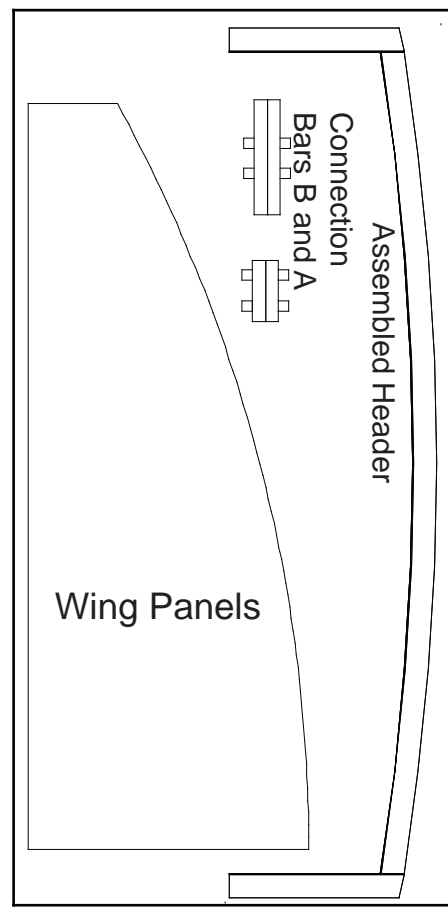

Level 1



Level 2

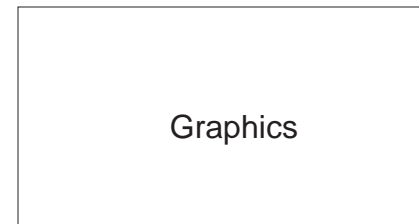
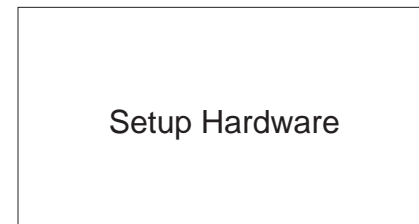

Level 3

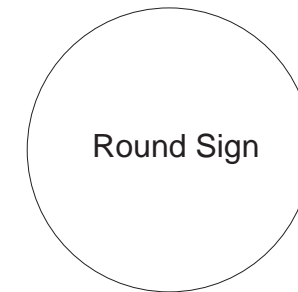

WHEN DISASSEMBLING ALUMINUM EXTRUSION, TIGHTEN ALL SETSCREWS AND LOCKS TO PREVENT LOSS DURING SHIPPING